

Article number: 206178A

Description: E+G Steel indexing plunger
GN 617-8-A

Measures

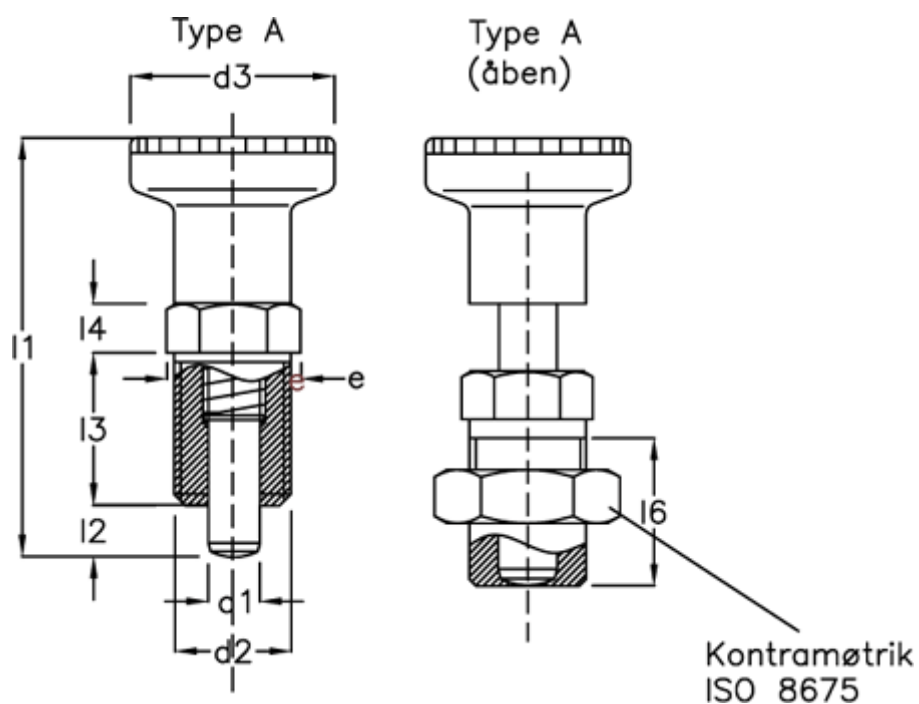

$d1 = 8$	$l6 = 23$
$d2 = M16 \times 1,5$	$NV = 19$
$d3 = 31$	Spring pressure N bottom = 31
$e = 21.9$	Spring pressure N top = 12.0
$l1 = 69.0$	
$l2 = 8$	
$l3 = 26$	
$l4 = 8$	